

Tray, Standing

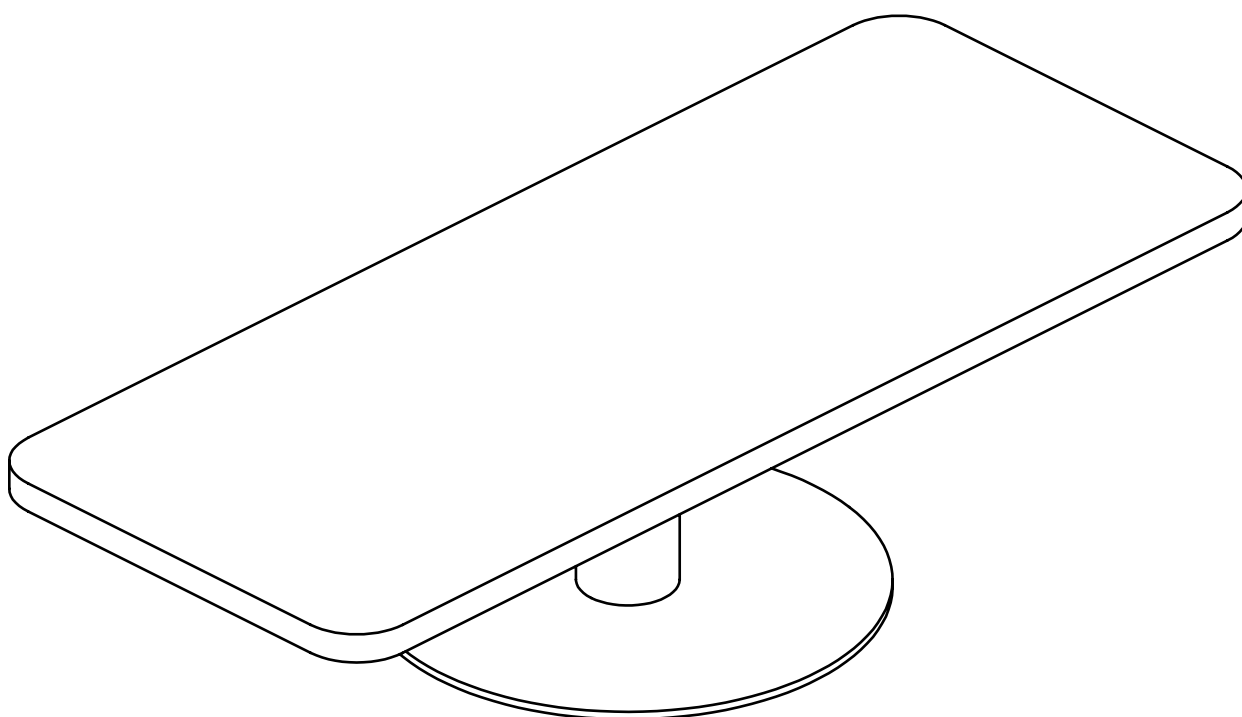

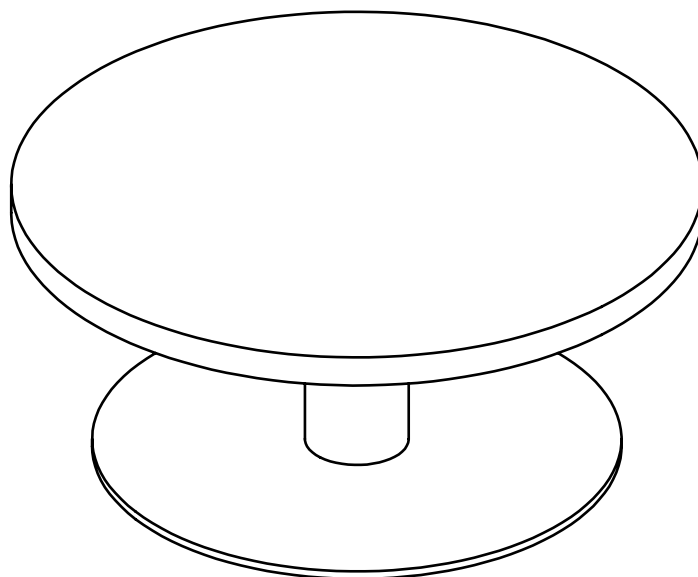

1 1X

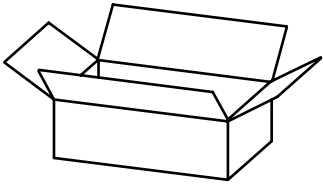
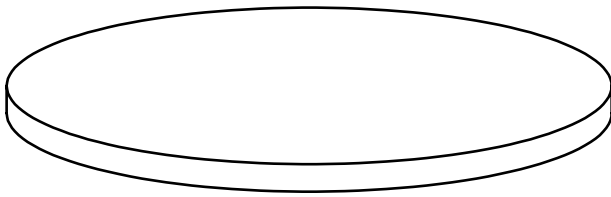

2 1X



3 1X

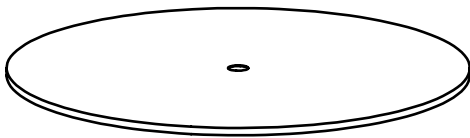

4 1X

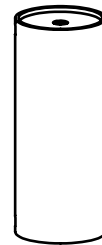

5 2X



6 4X



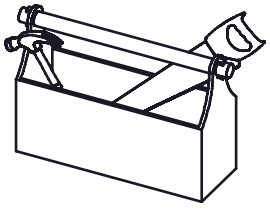

Umbraco Hex 5

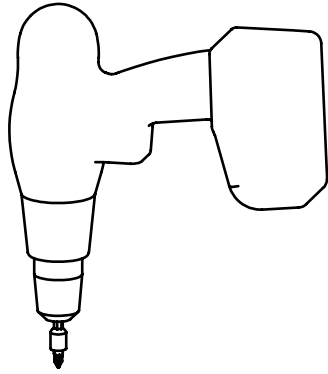

Screwdriver bit pz

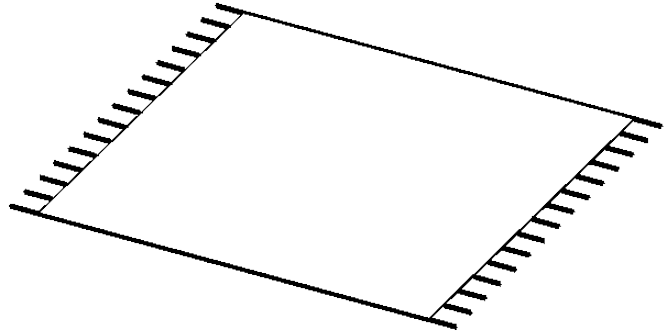

1

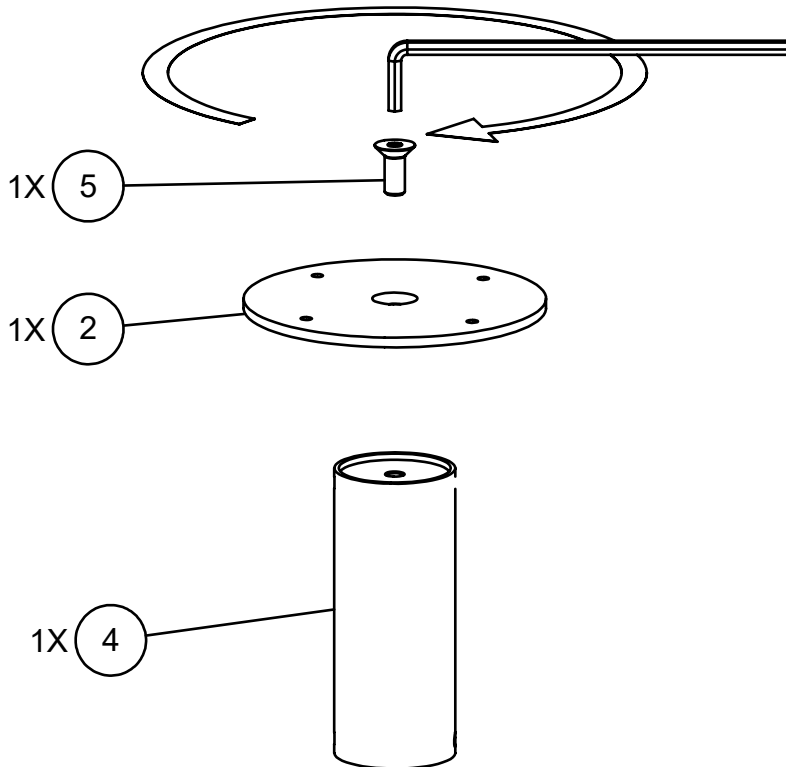

2

Tightening torque
for screws = 2 Nm

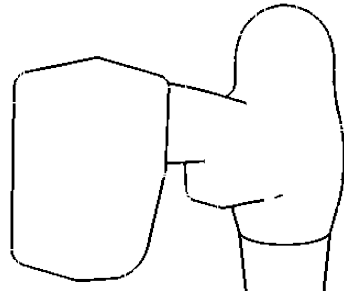

6 4X

1 1X

3

1X 6

1X 3

